



ALLEN CODING
A DIVISION OF ITW

a:touch 2

Universal control panel for Allen thermal transfer printers



OPERATING INSTRUCTIONS

Important notes

Operating instructions

Description	Version
<i>a:touch 2</i>	V1.03

The operating manual is a translation of the original operating instructions.

Applicability

The present operating instructions apply to devices with the following article number.

Device name

Article Number	Description
190200	<i>a:touch 2</i>

Using this manual

- First read the Chapter on “**Safety information**” before you begin working with the device.
- The operating manual enables safe working on and with the device. It is essential that you comply with all safety instructions contained therein.
- Read the complete operating manual before installing and commissioning the device.
- The operating manual is a part of the device. It has to be stored so that every person that works on and with the device has access to it at all times. The manual must be complete and in an easily readable condition.
- When the device is passed on, you have to enclose the operating manual.
- If the operating manual is lost, please ask for a replacement. Information on the current version of the operating manual may be found on our website **www.AllenCoding.com**.
- The information provided in these Operating Instructions relate to the devices described under “**Applicability**”.

Copyright

The present document and the described devices therein belong to the company Allen Coding GmbH. All rights remain reserved. Reproduction of this document, in full or in part, requires prior explicit and written approval of the company Allen Coding GmbH.

©Copyright 2016 Allen Coding GmbH, all rights reserved.

Disclaimer

The company Allen Coding GmbH undertakes all measures to ensure that the published document is up to date at the time of publication. However, no guarantee may be given that the document is error-free. The Allen Coding GmbH does not accept liability for possible damages that may have been caused by faulty information in this document. The company Allen Coding GmbH reserves the right to change the present document at any time without prior notice and to alter its content regarding continuous product improvement.

Manufacturer

Allen Coding GmbH
Friedrich-Bergius-Ring 30
D-97076 Würzburg
Direct +49 931 250 76 - 0
Fax +49 931 250 76 – 50
Email: info@AllenCoding.com
Website: www.AllenCoding.com

Table of contents

Important notes 3

Table of contents..... 4

1 Safety information..... 6

1.1 Configuration of the safety instructions 6

1.2 Used pictograms 7

1.3 Hazards during compliant use 7

2 Product identification 8

2.1 Characteristic data 8

2.2 Designated use 8

2.3 Qualification of personnel 8

2.4 Identification of the device 9

2.5 Compliance information 9

2.5.1 CE-compliance 9

2.5.2 EMC compliance statements 9

2.5.3 RoHS / WEEE – compliance..... 10

3 Product specifications 11

3.1 Safety requirements 11

3.2 Deliverable items 11

3.3 a:touch 2 interfaces 12

4 Unpacking and installation..... 14

4.1 Unpacking 14

4.2 Installation 15

5 Calibrating the touch panel 16

6 Operating 18

7 Cleaning and maintenance 19

7.1 Cleaning 19

7.2 Maintenance..... 19

7.2.1 Spare parts..... 19

7.2.2 Service address 20

8 Transport, storage and disposal 21

8.1 Transport 21

8.2 Storage..... 21

8.3 Disposal..... 21

9	Technical specifications.....	22
10	Scale drawing	24
	Appendix.....	25
A.	CE-compliance statement.....	25
B.	Spare parts.....	26

1 Safety information

This Chapter contains information on the configuration and relevance of the safety information presented in these operating instructions, and also information on possible hazards which may occur even for compliant usage of the device.

1.1 Configuration of the safety instructions

SIGNAL WORD







Type and source of hazard

Explanation of the hazard and information on possible consequences of non-compliance

- Activities/prohibited actions to help prevent accidents.

	The pictogram denotes the type of hazard	
	The safety sign  before the signal word indicates a possibility of personal injury	
	The signal word denotes the severity of the hazard	
	SIGNAL WORD	Consequences when hazard occurs
	HAZARD	Severe physical injury or death (irreversible)
	WARNING	Severe physical injury or death (irreversible)
	CAUTION	Slight/minor physical injury (reversible)
	ATTENTION	Property damage to machinery and/or to nearby assets
	The reference text describes: <ul style="list-style-type: none"> ▪ type and source of hazard, ▪ the possible consequences of disregarding the safety instruction, ▪ measures or restraints to prevent the hazard. 	

1.2 Used pictograms

Pictogram	Meaning
	Warning of a general hazard
	Warning of possible property damages
	Before performance, observe the corresponding information in the operating manual
	General note

1.3 Hazards during compliant use

 **CAUTION**



Potential hazard caused by incorrect accessories and spare parts!

The use of accessories and spare parts that are not recommended by the manufacturer may compromise safety, functionality and efficiency of the device. Any liability and warranty for any damages caused by not recommended accessories and spare parts or non-intended use is excluded by the manufacturer.

- Thus, use manufacturer recommended accessories and spare parts exclusively.
-

2 Product identification

2.1 Characteristic data

a:touch 2

Article Number	190200
WEEE-Reg.-Nr. DE	84410135
Unique Identification (5-digit)	e.g. 15001

2.2 Designated use

- The control panel *a:touch 2* is for monitoring and controlling thermal transfer printing systems of Allen Coding GmbH only.
- The USB interface may only be used to transfer data with a directly connected USB pen drive.

Reasonably foreseeable misuse:

- Operating the control panel *a:touch 2* with other systems than thermal transfer printing systems of Allen Coding GmbH.
- Other uses of the USB interface as for data transfer with a directly connected USB pen drive.
- Use of accessories and spare parts that are not recommended by the manufacturer.
- Operation / use of the control panel beyond the designated use defined by the manufacturer can endanger persons and / or cause property damage.

2.3 Qualification of personnel

Operation and set-up:

Operation and set-up of the device may only be performed by sufficiently qualified and trained personnel that have been authorized by operator to perform these tasks.

Installation, cleaning and maintenance:

Installation, cleaning and maintenance of the device may only be performed by fully qualified and trained technical personnel.

Maintenance:

Maintenance of the device may only be performed by the manufacturer's technical personnel or by fully trained and qualified technical personnel.

2.4 Identification of the device

Type plate

The type plate attached to the device contains the following data:

<p>①</p> <p>③</p> <p>④</p>	<p>a:touch2 190200</p> <p>S/N 15001</p> <p>YOM: 2015 PB1.0</p> <p>Made in Germany</p> <p>CE</p>	<p>②</p>  <p>ALLEN CODING A DIVISION OF ITW</p> <p>Direct: +49 931 250 76 0</p> <p>info@allencoding.com</p> <p>www.allencoding.com</p> <p>⑤</p> 
----------------------------	--	---

This Class A digital apparatus complies with Canadian ICES-003.
This device complies with Part 15 of the FCC Rules. Operation is subject to the following two conditions: (1) This device may not cause harmful interference, and (2) this device must accept any interference received, including interference that may cause undesired operation

① Device type with article number	④ CE identifier
② Manufacturer	⑤ WEEE identifier
③ Unique identification number	

2.5 Compliance information

2.5.1 CE-compliance



NOTE

CE-conformity

The product's CE conformance is certified by attachment of the CE symbol to the name plate. A sample of the declaration is found in the Appendix to these Operating Instructions; see "**CE-compliance statement**".

The device meets the requirements of the following European EC-Guidelines:

- EMC guideline **2004/108/EG**
- RoHS guideline **2011/65/EU**

2.5.2 EMC compliance statements

European Union (EU) Electromagnetic Compatibility Directive Compliance Statement

This product is in conformity with the protection requirements of EU Council Directive 2004/108/EC on the approximation of the laws of the Member States relating to electromagnetic compatibility.

This product has been tested and found to comply with the limits for Class A Information Technology Equipment according to the European Standard EN 55022.

Warning: This is an EN 55022 Class A product. In a domestic environment this product may cause radio interference in which case the user may be required to take adequate measures.

Federal Communications Commission (FCC) Emissions Compliance Statement

This equipment has been tested and complies with the limits for a Class A digital device, pursuant to Part 15 of the FCC Rules. These limits are designed to provide reasonable protection against harmful interference when the equipment is operated in a commercial environment.

This device complies with Part 15 of the FCC Rules. Operation is subject to the following two conditions:

(1) this device might not cause harmful interference, and (2) this device must accept any interference received, including interference that might cause undesired operation.

Warning: Operation of this equipment in a residential area is likely to cause harmful interference, in which case the user will be required to correct the interference at their own expense.

Industry Canada Class A Emissions Compliance Statement

This Class A digital apparatus complies with Canadian ICES-003.

2.5.3 RoHS / WEEE – compliance

RoHS

The product complies with the relevant provisions of the RoHS Directive for the European Union.

WEEE Directive Statement for the European Union

WEEE-Reg.-Nr. DE

84410135

In common with all Electronic and Electrical products the product should not be disposed of in household waste. Alternative arrangements may apply in other jurisdictions.

3 Product specifications

In this Chapter you will find information on the deliverable items and on the furnishings of the device.

3.1 Safety requirements



NOTE

Please always follow the safety instructions.
See Chapter “*Safety information*”.

3.2 Deliverable items



NOTE

Check the deliverable items for completeness and condition.

After receipt of the shipment, please check immediately to see whether all items listed on the delivery ticket are included and are undamaged. The manufacturer does not accept liability for deficiencies that have been claimed subsequently. Complain against:

- Transport damages directly to the shipping service.
- Deficiencies and/or incompleteness immediately to the manufacturer or your distributor.

The following components belong to the standard deliverable items for the device:

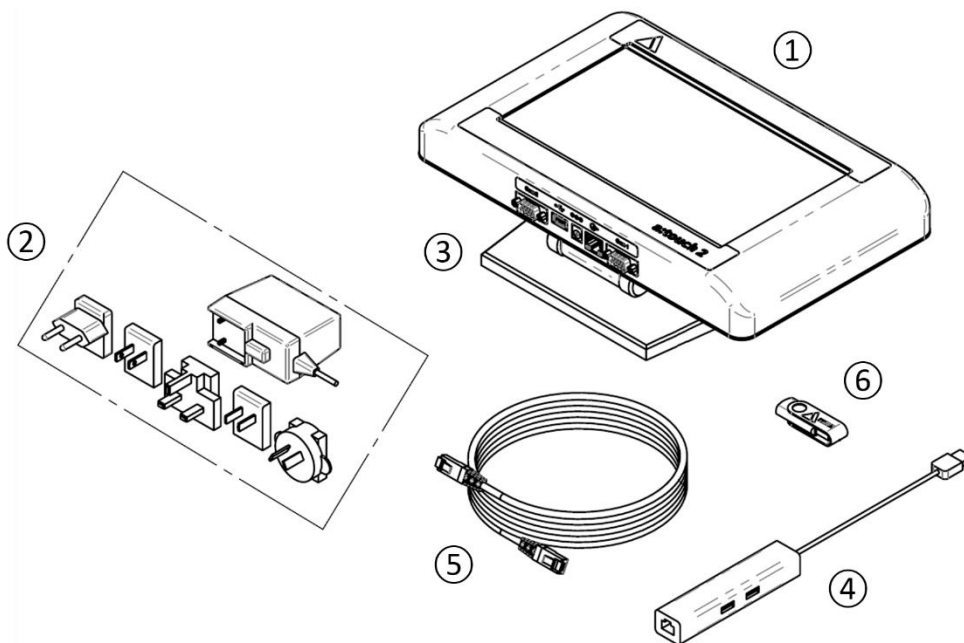

Position	Qty	Part number	Description
1	1	190200	a:touch 2
2	1	190238	Power supply 12V/24W - kit
3	1	190228	Base VESA 75/100 – assembled
4	1	108537	USB Ethernet adapter
5	1	-	Ethernet cable, CAT6, S/FTP, 3 m
6	1	-	Accessories USB stick

3.3 a:touch 2 interfaces

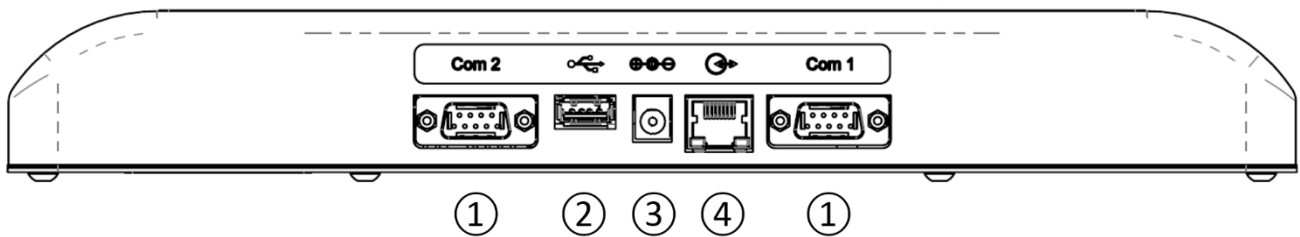

1. Communication interface RS-232 (D-Sub 9-pin connector) COM1 / COM2

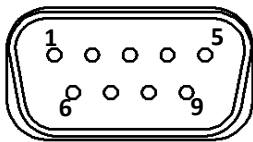

Pin	Description/Function
1	DCD – data carrier detect
2	RX – received data
3	TX – transmit data
4	DTR – data terminal ready
5	GND – common ground
6	DSR – data set ready
7	RTS – request to send
8	CTS – clear to send
9	RI – ring indicator

2. USB connection (port type A)

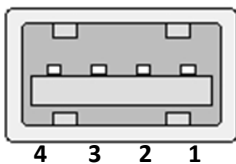

Pin	Description/Function
1	+ 5V
2	data -
3	data +
4	GND

3. Connector power supply (2.5 x 5.5 mm barrel plug; V+ plug center, V- plug outer)

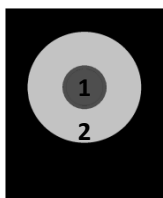

Pin	Description/Function
1	+12 V
2	Ground

4. Network connection (female connector RJ-45)

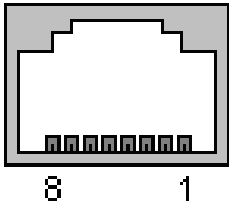

Pin	Description/Function
1	D1+
2	D1-
3	D2+
4	D3+
5	D3-
6	D2-
7	D4+
8	D4-

4 Unpacking and installation

In the following Chapter you will find information on unpacking and installation of the device.

4.1 Unpacking

CAUTION



Hazards due to defects or transport damage!

Transport damage to the device may result in unforeseeable hazards to personnel and/or property.

- On unpacking the device, check for any visible damage.
- Never connect a damaged device to the voltage supply or a printing system.
- Broken glass or plastic can cause injuries to hands. Liquids may emerge from a broken display. Avoid contact with this liquid. Clean carefully any body parts or clothing that have been exposed to these liquids.
- In case of transport damage, consult the manufacturer or your distributor.



NOTE

Check the deliverable items for completeness and condition.

After receipt of the shipment, please check immediately to see whether all items listed on the delivery ticket are included and undamaged. The manufacturer does not accept liability for deficiencies that have been claimed subsequently. File complaints with:

- Transport damages directly to the shipping service.
- Deficiencies and/or incompleteness immediately to the manufacturer or your distributor.



NOTE

Recycling of transport packing.

The transport packaging may be stored for later recycling, e.g. transport or storage.

Step 1: Open the transport packing.

Step 2: Check whether all items listed on the delivery ticket are included and undamaged.

Step 3: Remove all components of the device carefully from the transport packing.

4.2 Installation

 **CAUTION**



Potential hazard due to incorrect or non-compliant installation!

Incorrect or improper assembly of the device may impair safety, functionality and efficiency of the device.



- The installation of the device may be performed exclusively by qualified technical expert personnel.
 - Follow the relevant instructions in the operating manual.
-

ATTENTION



Damage to device due to condensate and overheating!

Exposing the device to excessive heat or cold while transport or storage, may cause damage to the device.

- Prior to startup, store the device for 24 hours within conditions corresponding to the later ambient conditions in respect to temperature and humidity. This ensures that the device can acclimatize.
-

Connect the power supply unit to the dedicated connector at the *a:touch 2* (connector 3). The system will boot up automatically afterwards.

5 Calibrating the touch panel

1. Close the software a:Control and click on [Start] - [All Programs] - [TouchKit] - [Configure Utility] to start the program for the calibration of the touch panel.
2. If a security notification arises, confirm by clicking [Yes].
3. A window with settings for the touch screen opens. Navigate to the “Tools” tab.

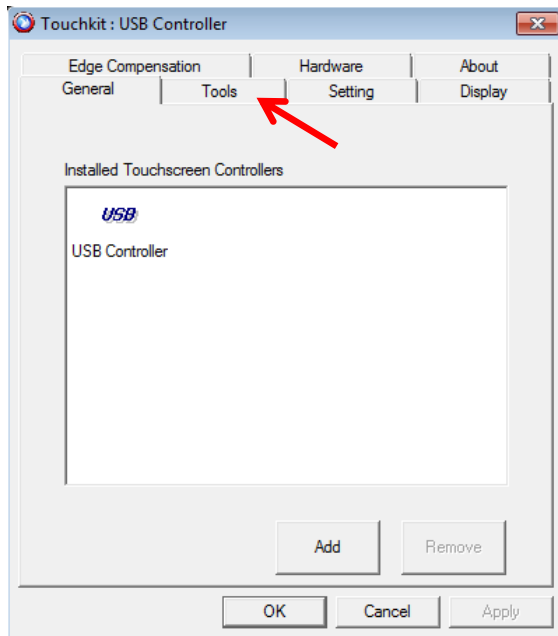

4. By clicking “4 Points Calibration” you switch to calibration mode.

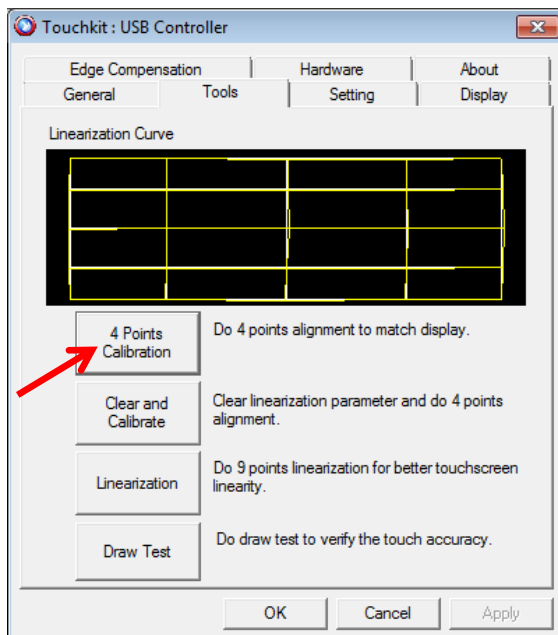

5. Touch the red-green flashing X-symbol and hold the position till the X-symbol stops flashing and remains green (about 3 to 4 seconds).



6. Repeat step 5 at the 3 next positions of the X-symbol.
7. At the end of the calibration, the new parameters will be saved. Confirm this step by pressing [OK].

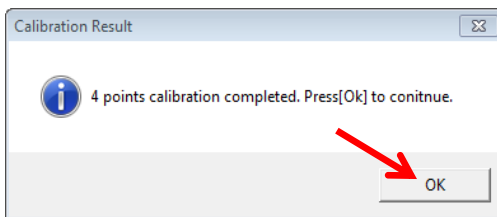

8. Close the setup window with [OK].

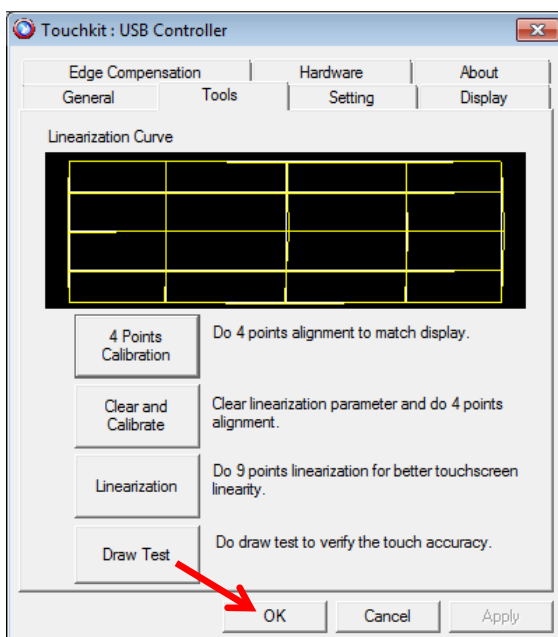

6 Operating

ATTENTION



Damage to the device due to deforming or shaking!

Bending and deforming may cause damage to the device or to components.
Do not expose the device to excessive shaking.

- Store the device in the designated mounting and install the mounting in a vibration-free place.
-

ATTENTION



Keep device dry!

Moisture and liquids of all sorts may cause damage to components or electrical circuits of the device.

- Do not switch on the device, if wet.
 - If the device is already switched on, turn it off immediately.
 - Dry the device and consult the manufacturer or distributor for repair or maintenance.
-

Touch screen

The *a:touch 2* is equipped with a touch screen. Operate the device by touching the screen with a fingertip or a specific polyacetal pen. Do not use any other means to operate the device.

Configuration

Due to the system configuration, the program for controlling Allen thermal transfer printers will start automatically.
The operation of the program is described in the respective operation manual.

Troubleshooting

Error messages are specific for each printing system. Please refer to the help section or the operation manual of the respective program.

7 Cleaning and maintenance

CAUTION



Hazards during cleaning and maintenance activities!

Switch off the device during cleaning and maintenance work, otherwise personnel safety may be at risk and damage to the device or other nearby property may result.

- Always deactivate the power supply to the device during cleaning and maintenance activities. Pull the mains plug.
 - During maintenance and during your absence, secure the device so that no changes may be performed by other persons or situations.
 - Maintenance and cleaning work may only be performed by trained personnel.
-

7.1 Cleaning

ATTENTION



Damage to the device due to improper cleaning!

Use of improper cleaning methods and the use of incorrect cleaning agents may result in damage to electronic and mechanical components of the device.

- Disconnect the device from the power supply before you begin cleaning.
 - Follow the cleaning instructions described in the operating manual.
 - Use only cleaning agents specified by the manufacturer.
-

Clean the *a:touch 2* with a soft clean cloth, if necessary. Permissible cleaning agents are water and isopropyl alcohol. Avoid moisture or liquid to intrude into the device and swipe drops from the device immediately.

7.2 Maintenance

ATTENTION



Damage due to improper maintenance – do not disassemble, modify or repair the device!

Changes to or modifications of the device may lead to the expiration of the manufacturer's warranty.

- For repair or maintenance, please consult the manufacturer or distributor.
-

7.2.1 Spare parts

Refer to the Spare Parts List under "*Spare parts*" in the appendix.

7.2.2 Service address



Germany

Allen Coding GmbH
Service Department
Friedrich-Bergius-Ring 30
D-97076 Würzburg
Tel.: +49 931 250 76 - 911
Fax +49 931 250 76 - 50
Email: support@allen.de

United Kingdom

Allen Coding
Unit 9, Gateway 1000,
Whittle Way, Arlington Business Park,
Stevenage, Hertfordshire SG1 2FP
Tel.: +44 1438 347 770
Fax +44 1438 347 771
Email: info@allencoding.co.uk

Website: www.AllenCoding.com



NOTE

Important information in case of defects

In case of defects in equipment, please provide the following information:

- Serial number/unique identification number
- Equipment type
- Description of fault
- Software- / Firmware-version
- Any affected components/assemblies

8 Transport, storage and disposal

8.1 Transport

Transport the device only in the packaging in which you received it.

8.2 Storage

Store the device only under the stated, permissible ambient conditions regarding temperature and humidity. Relevant information is found in this operating manual under "**Technical specifications**". Protect the device against dust and dirt.

8.3 Disposal

The device consists of various materials which can be recycled and which have to be disposed of separately.

In the event of disposal of the device, follow the relevant legal guidelines. Since the disposal guidelines may differ from country to country, please consult with your supplier as necessary.

Notes to disposal:

- Material types should be disposed of separately. The objective should always be an environmentally compatible disposal which ensures maximum recycling of materials.
- Observe the material and disposal instructions that may be present on certain individual parts.
- Make use of the opportunity to return materials to the manufacturer or supplier.

9 Technical specifications

a:touch 2	
Display	
Screen size	10.1" (25.65 cm)
Display dimensions [mm]	222.72 x 125.28
Native resolution (Pixel)	1024 x 600
Technology	TFT LCD
Colours	262.144
Backlight	LED
Operation	
Operation	touch
Touch technology	resistive 4-wire
System	
Processor	Intel® Atom™ N2600 1.6 GHz
Memory	2 GB DDR3 RAM
Storage	16 GB Flash (iSLC)
Operating system	Microsoft® Windows® Embedded Standard 7
Interfaces	
USB	1 x USB2.0 type A Use for data transfer with a directly connected USB pen drive only.
LAN	1 x 10/100 MBit Ethernet (RJ-45) Connection cable: Length: < 30 m Characteristics: shielded
Serial port	2 x RS-232 Connection cable: Length: < 3 m Characteristics: shielded
Power Supply	
Supply voltage	12 V DC
Power consumption (typical) [W]	9.96 (computer), 7.0 (display)
Dimensions	
Housing	
- front (B x H) [mm]	331 x 196
- depth [mm]	42
- weight [kg]	2.4
Ambient conditions	
Operating temperature [°C]	5 to 40
Storage temperature [°C]	-25 to 80
Humidity [%]	5 to 90 (non condensing)
Protection class	IP 20

Power supply

Power supply input

Voltage [V_{AC}]	100 - 240
Frequency [Hz]	50 - 60
Current [A]	0.58

Power supply output

Voltage [V_{DC}]	12
Current [A]	2
Power output [W]	max. 24

10 Scale drawing

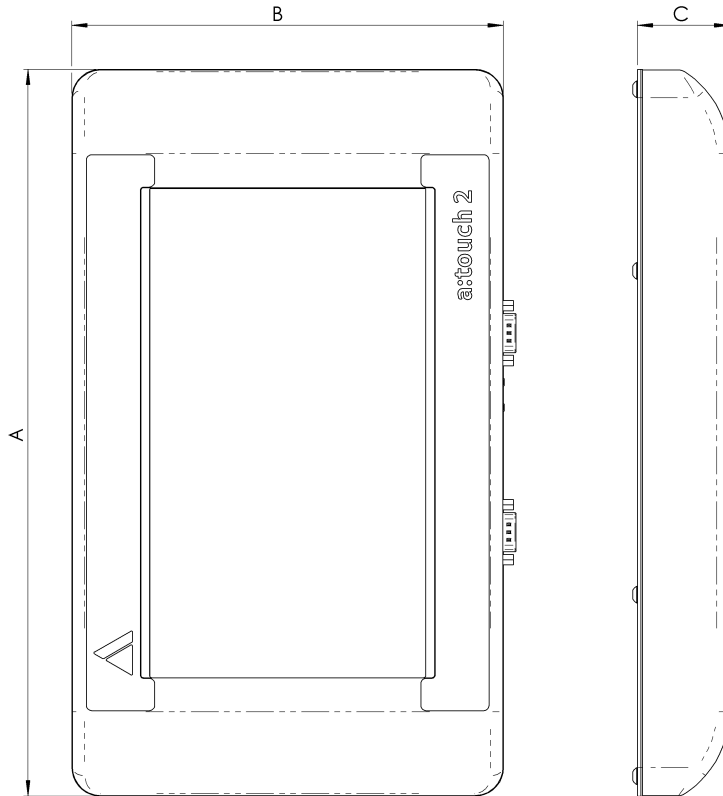

Dimensions (mm)		
A	B	C
331	196	42

Appendix

A. CE-compliance statement

EC-Declaration of Conformity a:touch 2



EC-Declaration of Conformity

according to EC EMC directive 2004/108/EC, Annex IV 2
(Translation of the EC Declaration of Conformity)

Hereby we declare that the equipment named in the following adheres to the protection requirements of the EC guideline 2004/108/EC in regards to its concept, design and version that is marketed by us. Changes that have not been coordinated with us will invalidate this declaration.

Manufacturer

Allen Coding GmbH
Friedrich-Bergius-Ring 30
D-97076 Würzburg

Direct: +49 931 250 76-0
Fax: +49 931 250 76-50
E-Mail: info@Allencoding.com
Website: www.AllenCoding.com

Equipment description

Function: Operation terminal for Printing-Systems
Type/Model: a:touch 2 - 190200
Year of construction: 2015

The conformity with addition guidelines/regulations that apply to the equipment is declared:

The object of the declaration described above is in conformity with Directive 2011/65/EU of the European Parliament and of the Council of 8 June 2011 on the restriction of the use of certain hazardous substances in electrical and electronic equipment.

The conformity of the named equipment with the rules of the EC guidelines named above is proved by conformity with the following standards:

Applied harmonized standards:

EN 55022:2010;
EN 55024:2010;
EN 55032:2012;
EN 61000-6-2:2005
EN 61000-3-2:2006 + A1:2009 + A2:2009
EN 61000-3-3:2013

Additional applied standards:

EN 55016-1-1:2007 + A1:2007 + A2:2008
EN 55016-1-2:2004 + A1:2005 + A2:2006
EN 55016-1-4:2007
EN 55016-2-3:2006
EN 55016-4-2:2004
EN 61000-4-2:2009
EN 61000-4-3:2006 + A1:2008 + A2:2010
EN 61000-4-4:2004
EN 61000-4-5:2006
EN 61000-4-6:2009
EN 61000-4-8:2010
EN 61000-4-11:2004
FCC, Part 15, Class A, verification
ICES – 003, Issue 5, August 2012

Details of signatory person

Dr. Stefan Balling
(Name of signer) R&D Manager
(Position)

Yolanda Atencia Hernandez
(Name of signer) Operations Manager
(Position)

Signature

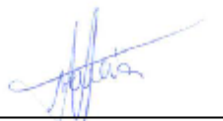
Signature

Würzburg, 03.02.2015
(Place, Date)

Würzburg, 03.02.2015
(Place, Date)

B. Spare parts

No.	Part number	Description
1	190200	<i>a:touch 2</i>
2	190238	Power supply 12V/24W - kit
3	190228	Base VESA 75/100
4	108537	USB Ethernet adapter